

VDI100 GENERAL PURPOSE FULL VECTOR INVERTER



GEFRAN



Gefran, With forty years of experience, Gefran is the world's leading designer and producer of solutions for **measuring, controlling, and driving industrial production processes.**

We have 14 branches in 12 countries and a network of over 80 worldwide distributors.

QUALITY AND TECHNOLOGY

Gefran components are a **concentration of technology**, the result of constant research and of **cooperation with major research centers.**

This makes Gefran synonymous with quality and expertise in the design and production of:

- **sensors** for measuring main variables such as **temperature, pressure, position and force**
- **state-of-the-art components and solutions for indication and control**, satisfying demands for optimization of processes and intelligent management of energy consumption
- **automation platforms** of various complexities
- **electronic drives and electric motors** in AC and DC for all industrial automation, HVAC, water treatment and lift needs.

Gefran's know-how and experience guarantee continuity and tangible solutions.

SERVICES

A team of Gefran experts works with each customer to select the ideal product for its application and to help install and configure devices (technohelp@gefran.com).

Gefran offers a wide range of courses at different levels for the technical-commercial study of its product as well as specific courses *on demand*.



APPLICATIONS



CONVEYOR AND TRANSPORTATION MACHINERY

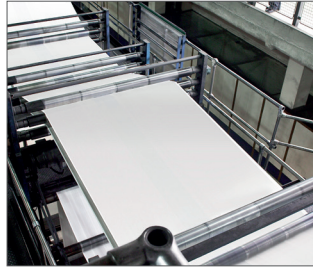

PAPER MAKING MACHINE



MACHINE TOOL/METAL PROCESSING MACHINERY



WOOD WORKING MACHINERY



HVAC AND PUMP SYSTEMS



PAPER/TEXTILE MACHINE



GRAVITATIONAL HANDLING EQUIPMENT

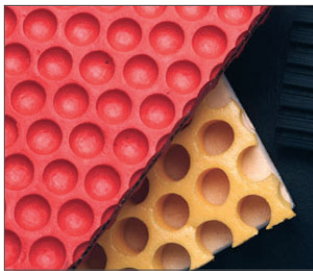

PLASTICS / RUBBER PROCESSING MACHINE

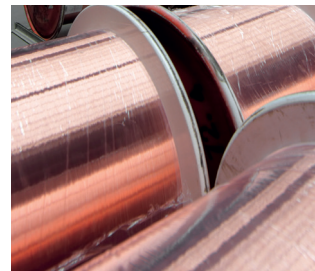

WIRE / CABLE MAKING MACHINE

In addition to foreseeing the market's application needs, Gefran forms partnerships with its customers to find **the best way to optimise and boost the performance of various applications.**

Gefran products communicate with one another to provide integrated solutions, and can dialogue with devices by other companies thanks to compatibility with numerous fieldbuses.

Modbus

PROFINET
BUS

CANopen

DeviceNet

DESCRIPTION



The GEFRAN range of VDI100 inverters is specifically designed to give the utmost flexibility of application to modern automation systems and ensure ease of use, while guaranteeing advanced control capabilities for both asynchronous and permanent magnet SPM and IPM motors.

VDI100 inverter features an intuitive and user friendly interface to enable immediate motor start-up and system functions to implement control architectures for the most advanced application solutions, all with maximum energy efficiency.

The VDI100 series offer a perfect automation system integration with "universal" standard configuration, optional cards and accessories. All these elements offer real advantages in terms of product and system optimization and cost saving.

- > Wide motor control capability
- > Advanced auto-tuning
- > High level sensor vector mode
- > Fast computing ability
- > Conformity to global standards.

POWER RANGE

	Power																		
kW (Hp)	0.75 (1.0)	1.5 (2.0)	2.2 (3.0)	3.7 (5.0)	5.5 (7.5)	7.5 (10)	11 (15)	15 (20)	18.5 (25)	22 (30)	30 (40)	37 (50)	45 (60)	55 (75)	75 (100)	90 (125)	110 (150)	130 (175)	160 (215)
230 Vac, 3ph	Size 1			Size 2		Size 3	Size 4		Size 5										
400 Vac, 3ph	Size 1			Size 2		Size 3		Size 4		Size 5			Size 6		Size 7				
400 Vac -F, 3ph	Size 1			Size 2		Size 3		Size 4		Size 5									

DRIVE TYPE DESIGNATION

VDI100-XXXX-KXX-X-Y



EMI Filter:	F = included; [Empty] = not included
Rated voltage:	2T = 230 Vac (200...240 Vac), 3ph; 4 = 400 Vac (380...480 Vac), 3ph
Software:	X = standard
Braking unit:	B = included; X = not included
Keypad:	K = Integrated (LED keypad with 5-digits 7-segment display)
Drive power, in kW	
Mechanical drive sizes	
VDI100 drive series	

WEIGHTS AND DIMENSIONS

Mechanical size - Protection degree	Dimensions: Width x Height x Depth		Weight	
	mm	inches	kg	lbs
1 - IP20/NEMA 1	130 x 215 (306*) x 150	5.12 x 8.46 (12.04*) x 5.9	2.2 (3.5*)	4.8 (7.7*)
2 - IP20/NEMA 1	140 x 279 (400*) x 177	5.51 x 10.98 (15.75*) x 6.97	3.8 (3.5*)	8.4 (7.7*)
3 - IP20/NEMA 1	210 x 300 (416.5*) x 215	8.26 x 11.81 (16.4*) x 8.46	6.2 (8*)	13.7 (17.6*)
4 - IP20/NEMA 1	265 x 360 (500*) x 225	10.43 x 14.17 (19.68*) x 8.56	10 (12.5*)	22 (27.5*)
5 - IP20/NEMA 1	286.5 x 525 (679*) x 252	10.57 x 9.92 (26.73*) x 29.92	30 (32.5*)	66.1 (71.6*)
55kW only	286.5 x 525 x 252	10.57 x 9.92 x 29.92	35	77.1
6 - IP00 (NEMA 1)	344 [348.5] x 580 [740] x 300 [300]	13.54 [13.72] x 22.83 [29.13] x 11.81 [11.81]	46.7 [49.7]	102.9 [109.5]
7 - IP00 (NEMA 1)	459 [463.5] x 790 [1105] x 324.5 [324.5]	18.07 [18.24] x 31.1 [43.5] x 12.77 [12.77]	88 [94.4]	194 [208.1]

* with filter

GENERAL CHARACTERISTICS

Control Characteristics	Motor type	Asynchronous and Synchronous Motor (Surface Permanent Magnet Motor, Interior Permanent Magnet Motor)
	Control Modes	V/f, V/f+Encoder, SLV (vector control open loop), SV (vector control closed loop), PMSLV (vector control open loop for Permanent Magnet Motor, PMSV (vector control closed loop for Permanent Magnet Motor)
	Speed control accuracy	±1% (SLV, overload 200% and control range 1 : 30 (60...2Hz ; 50...1.6Hz)), ±1% (SLV, overload 150% and control range 1 : 50 (60...1.2Hz ; 50...1Hz)), ±1.5% (V/f open-loop, overload 150% and control range 1 : 40 / 60...1.5Hz ; 50...1.25Hz), ±0.1% (SV)
	Output Frequency	0.1Hz-599Hz
	Output Frequency Resolution	0.01Hz
	Overload Tolerance	<ul style="list-style-type: none"> Heavy Duty Mode (HD.): 150% rated current for 60sec, 200% rated current for 2 sec. (Factory default) Normal Duty Mode (ND.): 120% rated current for 60sec
	Frequency Setting Signal	0 to +10V, -10V to +10V, 4 to 20mA or pulse train input
	Acceleration / Deceleration Time	0.0 - 6000.0 sec (separate acceleration and deceleration time set)
	Voltage / Frequency Characteristics	15 fixed + one customized V/f pattern
	Braking Unit	Built-in braking transistor on 3ph 400V Class 0.75-30kW HD and on 3ph 200V Class 0.75-18.5kW HD
	Display	LED keypad with 5-digits 7-segment display (LCD keypad option)
	Main Control Functions	Auto-tuning, Zero Servo, Torque Control, Position Control, Droop, Soft-PWM, Over-Voltage Protection, Dynamic Braking, Speed Search, Frequency Traversing, Momentary Power Loss Restart, PID Control, Automatic Torque Compensation, Slip Compensation, RS-485 Communication, Close Loop Control with encoder, Simple PLC Function, 2 Analog Output, Run Permissive inputs, Application Presets
	Other Functions	Records of Power ON and Operation Time, 4 Fault History Records and Latest Fault State Record, Energy-Saving Function, Phase Loss Protection, DC Braking, Mechanical Brake Control, Dwell, S Curve Acceleration and Deceleration, Pulse input / output, Display of Engineering Unit, NPN / PNP Selection
Protection Functions	Stall Prevention	During Acceleration, Deceleration and continuous run
	Over Current (OC) and Output Short-Circuit (SC) Protection	When the current exceeds 200% of the inverter rated current
	Inverter Overload Protection (OL2)	Inverter stops when the output is higher than below conditions. <ul style="list-style-type: none"> Heavy Duty Mode (HD.): 150% rated current for 60sec, 200% rated current for 2 sec. (Factory default), Carrier frequency is from 2kHz to 8kHz Normal Duty Mode (ND.): 120% rated current for 60sec, Carrier frequency is 2kHz
	Motor Overload Protection (OL1)	Electrical overload protection curve
	Over Voltage Protection (OV)	OV threshold = 410Vdc (230V class), 820Vdc (400V class)
	Under Voltage (UV)	UV threshold = 190Vdc (230V class), 380Vdc (400V class)
	Momentary Power Loss Restart	When Power loss exceeds 15ms. This function can be set up to 2 sec
	Overheat Protection (OH)	Thermistor sensor on heatsink
	Ground Fault Protection (GF)	Protection by current detection circuit
	Charge Indicator	When main circuit DC voltage ≥ 50V, the CHARGE LED is on
Output Phase Loss Protection (OPL)	If the OPL function acts, the motor stops rotation automatically	
Environment Specification	Protection degree	Sizes 1 to 5: IP20 / NEMA 1, with standard removable anti dust cover Sizes 6-7: IP00; available optional NEMA 1 kit (cover and conduit box)
	Operating Temperature	-10~+50°C (Sizes 1 to 5 without anti dust cover; sizes 6 -7) -10~+40°C (Sizes 1 to 5 with anti dust cover; sizes 6 -7 with NEMA 1 kit) Up to +60°C with derating.
	Storage Temperature	-20 ~ +70°C
	Humidity	95% RH or less (no condensation)
	Altitude	Altitude of 1000 meters or lower
	Vibration	1.0G, in compliance with IEC 60068-2-6
Communication Function	Built-in: RS-485 with Modbus RTU / ASCII (standard RJ45 connection) Optional: Profibus/CANopen/DeviceNet/TCP-IP	
DC choke	Built-in on 3ph 400V Class 75-160kW HD	
EMI filter	Add-on module on -F version 3ph 400V Class 0.75-45kW HD In compliance with EN61800-3 standard	
Certification		Complies with the EC Directive concerning low voltage equipment (Directives LVD 2014/35/EC, EMC 2014/30/EC) In compliance with EN61800-3 (CE & RE) and EN61800-5-1(LVD) Conformity to RoHS directive
		UL508c
Encoder expansion card (optional)	Asynchronous Motor: Digital incremental Line driver and Open collector, Resolver PM motor: Digital incremental Line driver, Resolver, SinCos	

GENERAL CHARACTERISTICS

SMART FUNCTIONS INTEGRATED

VDI100 integrates intelligent functions to simplify system integration, reduce costs and improve comfort in industrial environment.

- > Intelligent over voltage suppression
- > Advanced motor auto-tune
- > Ultra low motor noise with Soft-PWM
- > Application presets.



I/O CONFIGURATION

The VDI100 inverter features a standard I/O card specially developed to give maximum flexibility for the user.

- > Digital input: 8, NPN/PNP
- > Digital output: 2 (size 1) / 1 (all other sizes)
- > Analog input: 2, AI1: -10~10V / 0~10V, AI2: 0~10V / 4~20mA
- > Analog output: 2, AO1: 0~10V, AO2: 0~10V/4~20mA
- > Relay output: 1 (size 1) / 2 (all other sizes)
- > Others: PTC input (AI2), Pulse input (32kHz), Pulse output (32kHz).

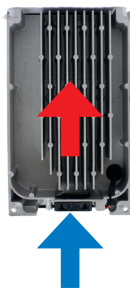

ROBUST DESIGN

Coated PCB offers protection for harsh environments.

All models have fan cooled external heatsinks which eliminate ingress of dust.



SERIAL COMMUNICATION

Modbus

The VDI100 integrates a standard RS485 serial line with Modbus RTU/ASCII protocol, for peer-to-peer or multidrop connections.

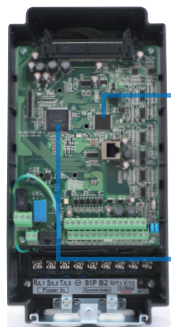

DUAL CORE PROCESSORS

High Performance & Reliability.

- **32Bit MCU**
Mass computing capability for advanced current vector control technology. Minimizes the internal loop time for higher control response.
- **ASIC (from size 2)**
Prevents inrush current damage to IGBT module. Enhances the reliability and life expectancy of motor drive.

"UNIVERSAL" IN MOTOR TECHNOLOGIES

Simple parameter settings for easy switching between asynchronous and permanent magnet motors.

High performance current vector control for a wide range of motors types.



Asynchronous Motor

- > Competitive
- > Mechanical Robustness

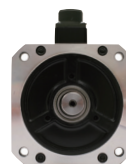

Surface Permanent Magnet Motors (SPM)

- > High Efficiency
- > High power density
- > Low Cogging Torque



Interior Permanent Magnet Motors (IPM)

- > Highly Efficiency
- > Compact Size
- > With Reluctance Torque

FAN CONTROL AND EASY MAINTENANCE

Fan control achieves low noise levels and long-lasting fan.

Easy access to fan allows simple and quick maintenance and replacement.



INTEGRATED KEYPAD

The integrated programming keypad with 5 Digit 7 Segment LED display provide fast programming and immediate start-up.

OPTIONAL LCD PROGRAMMING KEYPAD

The optional LCD programming keypad with clear and wide parameter display in multiple languages, makes the VDI100 extremely intuitive and easy to use.

The keypad can also be used remotely and as a copy unit to copy parameter settings from one drive to another.

FIELDBUS

The VDI100 can be easily integrated into machine architectures through optional Profibus, CANopen, Devicenet and TCP-IP communication modules.

Model	Description
EXP-PDP-BDI/VDI	Profibus DP interface module
EXP-TCPIP-BDI/VDI	Ethernet TCP/IP interface module
EXP-DN-BDI/VDI	DeviceNet interface module
EXP-CAN-BDI/VDI	CanBus interface module



RJ45 TO USB CONNECTING CABLE

For the connection between inverter and PC using Gf_eXpress and PC Tools configurator.



Model	Description
Cable RJ45 to USB 1.8m	RJ45 to USB connecting cable (1.8 m. cable)
Cable RJ45 to USB 3m	RJ45 to USB connecting cable (3 m. cable)



COPY UNIT

- > Copying parameters settings from one AC drive to another.
- > Can be used as remote keypad.
- > Standard RJ45 interface cable.

ENCODER FEEDBACK EXPANSION CARDS

> EXP-OC-VDI100

Digital incremental open collector encoder card.

- For Asynchronous motor
- Support Open Collector type and pulse signal



Terminals	Description
Vcc	Power Supply for encoder: 12V/5V±5%, 200mA
GND, /A, /B, /Z	Power Source and Input Signal Common
A, B, Z	Encoder Signal Input Terminal (Open Collector Type)
AO, BO, ZO,	Pulse monitor output: Open Collector Type, 24V, 30mA
/AO, /BO, /ZO	Output Signal Common
E	Shielding connection

> EXP-LD-VDI100

Digital incremental Line driver encoder card.

- For Asynchronous motor
- Support Line Driver type and complementary type pulse signal



Terminals	Description
Vcc	Power Supply for encoder: 12V/5V±5%, 200mA
GND	Power Source and Input Signal Common
A, /A, B, /B, Z, /Z	Encoder Signal Input Terminal (Line Driver Type), RS-422 Level Output
AO, /AO, BO, /BO, ZO, /ZO	Pulse monitor output: Line Driver Type, RS-422 Level Input
E	Shielding connection

> EXP-LD-PM-VDI100

Digital incremental Line driver encoder card with Hall sensor.

- For Permanent Magnet motor
- Support Line Driver type and complementary type pulse signal



Terminals	Description
Vcc	Power Supply for encoder: 5V±5%, 200mA
GND	Power Source and Input Signal Common
A, /A, B, /B, Z, /Z, /U, /V, /W, /W	Encoder Signal Input Terminal (Line Driver Type), RS-422 Level Input
AO, /AO, BO, /BO, ZO, /ZO	Pulse monitor output: Line Driver Type, RS-422 Level Output
E	Shielding connection

> EXP-RS-PM-VDI100 (*)

Resolver card for SPM / IPM Permanent Magnet motor and Asynchronous.



Terminals	Description
R1, R2, S1, S2, S3, S4	R1-R2: Sinusoidal excitation signal. 7Vrms, 10kHz. Transformation ratio: 0.5±5% S1-S3: analog input of Sine signal. S2-S4: analog input of Cosine signal.
AO, /AO, BO, /BO, ZO, /ZO	A and B phase output terminal; Z phase monitoring output terminal. Line Driver output type: RS-422 Level output
E	Shielding connection

(*) this card is not applicable on size 1 models:

- VDI100-1007...1015-KBX-2T
- VDI100-1007...1022-KBX-.-4

> EXP-SC-PM-VDI100

SinCos encoder card for Permanent Magnet motor



Terminals	Description
E5V	Power supply for encoder 5V±5%, 200mA
GND	Power supply common
C+, C-	Input C pulse from the encoder, Vpp= 0.6-1.2V
D+, D-	Input D pulse from the encoder, Vpp= 0.6-1.2V
A+, A-	Input A pulse from the enc., Vpp= 0.6-1.2V, fmax=20KHz
B+, B-	Input B pulse from the enc. Vpp= 0.6-1.2V, fmax=20KHz
R+, R-	Input R pulse (encoder home pulse)
a+, a-	Output a ratio of the A pulse frequency
b+, b-	Output b ratio of the B pulse frequency
E, E	Shielding connection: wire and inverter terminal "E"

WIRING DIAGRAM

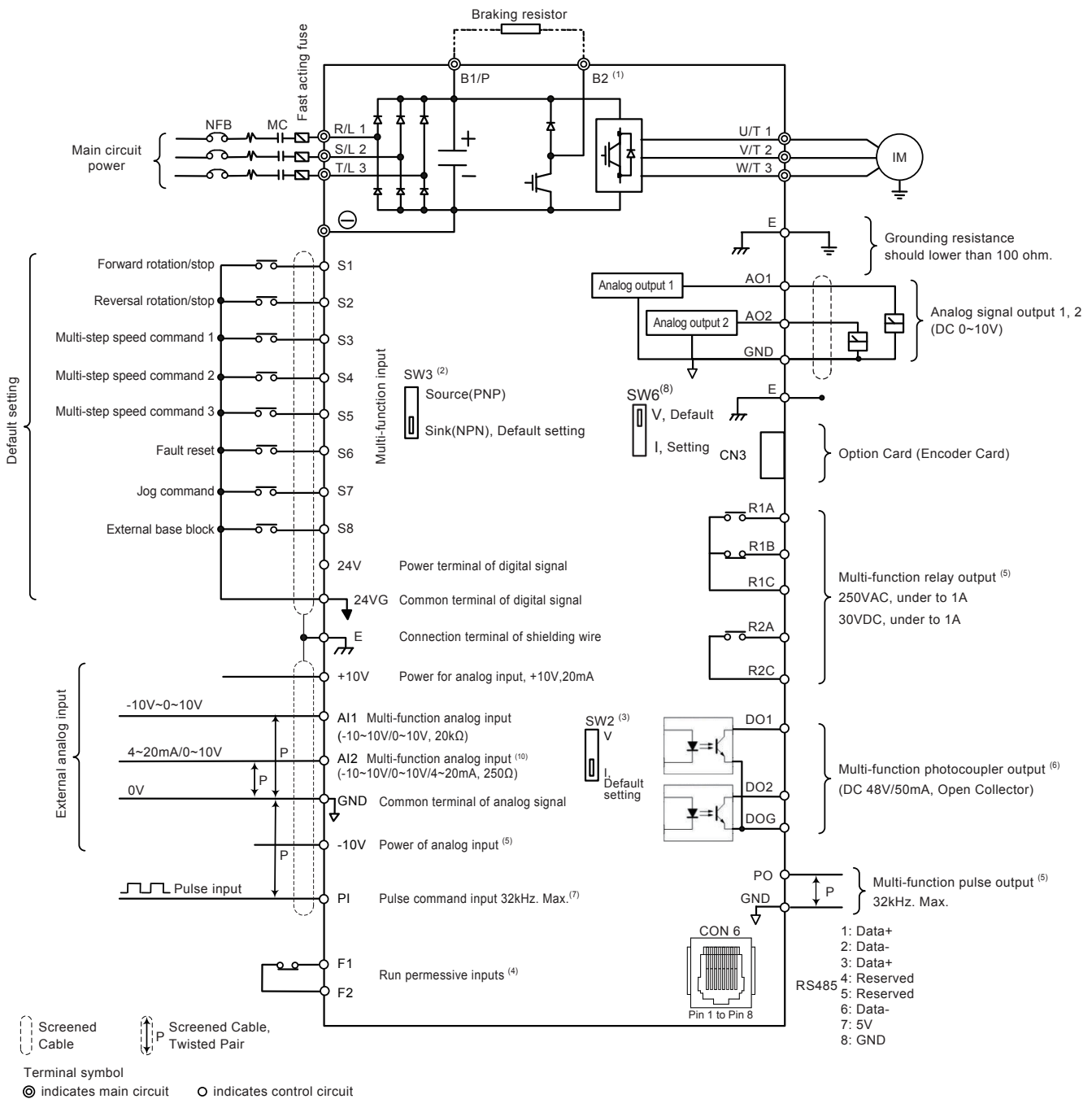

- (1) The main circuit of 200V 0.75~18.5kW and 400V 0.75~30kW (included) with built-in braking transistor provide terminal B2. The braking resistor can be connected directly between B1 and B2. Optional braking module is available for the other models.
- (2) The multi-function digital input terminals S1~S8 can be set to Source (PNP) or Sink (NPN) mode by SW3 switch.
- (3) Multi-function analog input 2 (AI2) can be set to the voltage command input [0~10/-10~10V] or the current command input [4~20mA] through SW2 switch.
- (4) When integrated Run Permissive inputs is NOT used, connect a link across terminals F1 & F2 for the inverter output to function. External safety circuits can be interfaced with inverter using terminals F1 and F2.
- (5) Terminals -10V (S+), (S-), R2A~R2C and PO-GND are provided for 200V 2.2kW and 400V 3.7kW ratings or above.
- (6) Terminal DO2 is provided for 200V 1.5kW and 400V 2.2kW ratings or below (size 1).
- (7) When using open collector input, there is no need of resistance because of built-in pull-up resistance.
- (8) AO2 default setting is 0~+10V.
- (9) 400V class 75kW~160kW have built-in DC reactors.
- (10) Multi-function analog input 2 (AI2) can be set as PTC Overheat Protection.

CHOOSING THE INVERTER: INPUT AND OUTPUT DATA

SINGLE PHASE / THREE PHASE – 230V CLASS

Sizes VDI100			1007	1015	2022	2037	2055	3075	4110	4150	4185	5220	
Output Rating ⁽²⁾	HD ⁽³⁾	Rated Output Capacity	KVA	1.9	3	4.2	6.7	9.5	12.6	17.9	22.9	27.8	32.4
		Rated Output Current	A	5	8	11	17.5	25	33	47	60	73	85
		Maximum Applicable Motor ⁽¹⁾	HP	1	2	3	5	7.5	10	15	20	25	30
	ND ⁽⁴⁾	Rated Output Capacity	KVA	2.3	3.7	4.6	8.4	11.4	16.0	21.3	26.3	30.1	41.9
		Rated Output Current	A	6	9.6	12	22	30	42	56	69	80	110
		Maximum Applicable Motor ⁽¹⁾	HP	2	3	5	7.5	10	15	20	25	30	40
Maximum Output Voltage		V	Three-Phase, 200V to 240V										
Maximum Output Frequency		Hz	0.1-599 (Based on parameter setting)										
Input Power	Rated Voltage, Frequency		Single-Phase / Three-Phase, 200V to 240V, 50/60Hz					Three-Phase, 200V to 240V, 50/60Hz					
	Allowable Voltage Fluctuation		-15% ~ +10%										
	Allowable Frequency Fluctuation		±5%										
HD	Rated Input Current	A	(9,4*) 5,4	(14,7*) 8,5	(20,3*) 11,7	18,7	26,3	34,5	51,1	65,2	79,4	92,4	
		ND	(11,3*) 6,5	(17,9*) 9,6	(22,1*) 12,8	22,3	31,6	41,7	60,9	75	85,9	119,6	
Power-loss	Watt Loss		W	107	145,5	166,6	288	461,2	600,3	733,1	961,7	1021,3	1562,7
	Heat Loss		kcal/hr	92	125,1	143,3	247,7	396,6	516,3	630,5	827,1	878,3	1343,9
	Switching Frequency		kHz	8	8	8	8	8	8	8	8	6	5
Braking Transistor			Built-in									(6)	

THREE PHASE – 400V CLASS

Sizes VDI100			1007	1015	1022	2037	2055	3075	3110	3150	4150-F	4185	4220	5300	5370	5450	5550	6750	6900	71100	71320	71600
Output Rating ⁽²⁾	HD ⁽³⁾	Rated Output Capacity	KVA	2.6	3.2	4.2	7	11.3	13.7	18.3	23.6	29.7	34.3	45.7	57.2	69.3	89.9	114	137	165	198	225
		Rated Output Current	A	3.4	4.2	5.5	9.2	14.8	18	24	31	39	45	60	75	91	118	150	180	216	260	295
		Maximum Applicable Motor ⁽¹⁾	HP	1	2	3	5	7.5	10	15	20	25	30	40	50	60	75	100	125	150	175	215
	ND ⁽⁴⁾	Rated Output Capacity	KVA	3.1	4.1	5.3	9.2	13.3	17.5	23.6	29.0	33.5	44.2	55.6	67.1	78.5	111	128	159	191	226	250
		Rated Output Current	A	4.1	5.4	6.9	12.1	17.5	23	31	38	44	58	73	88	103	145	168	208	250	296	328
		Maximum Applicable Motor ⁽¹⁾	HP	2	3	5	7.5	10	15	20	25	30	40	50	60	75	100	125	150	175	210	250
Maximum Output Voltage		V	Three-Phase, 380V to 480V																			
Maximum Output Frequency		Hz	0.1-599 (Based on parameter setting)																			
Input Power	Rated Voltage, Frequency		Three-Phase, 380V to 480V, 50/60Hz																			
	Allowable Voltage Fluctuation		-15% ~ +10%																			
	Allowable Frequency Fluctuation		±5%																			
HD	Rated Input Current	A	3,7	5,3	6	9,6	15,5	18,7	25	33,7	42,4	48,9	65,2	81,5	98,9	130	159	181	229	275	325	
		ND	4,5	5,9	7,5	11,6	18,2	24	32,3	41,3	47,8	58,7	78,3	95,7	112	159	181	229	275	325	361	
Power-loss	Watt Loss		W	127,4	134,7	171,7	241,9	294,1	697,7	829,7	880,5	1109,4	1172,5	1666,5	1965,9	2562,8	1755	1955	2260	1660	2060	2560
	Heat Loss		kcal/hr	109,6	115,8	147,7	208	252,9	600	713,5	757,2	954,1	1008,4	1433,2	1690,7	2204	1509,3	1681,3	1943,6	1427,6	1771,6	2201,6
	Switching Frequency		kHz	8	8	8	8	8	8	8	8	8	8	5	5	5	5	5	5	5	5	5
Braking Transistor			Built-in										Option (External Braking Module)									

Inverter Voltage and Capacity		HD mode carrier freq range	HD mode carrier freq default setting
200V Class	400V Class		
0.75 ~ 15 kW	0.75 ~ 22 kW	2-16 kHz	8 kHz
18.5 kW	-	2-12 kHz	6 kHz
22 kW	-	2-12 kHz ⁽⁵⁾	5 kHz
-	30 ~ 37 kW	2-12 kHz ⁽⁵⁾	5 kHz
-	45 ~ 132 kW	2-10 kHz ⁽⁵⁾	5 kHz
-	90 kW	2-10 kHz	4 kHz
-	160 kW	2-8 kHz	3 kHz

- (1) Based on the standard 4-pole induction motor. The selected inverter must have a higher output current rating than the motor.
- (2) The default setting of VDI100 is HD (heavy duty mode). To switch VDI100 to ND (normal duty mode) set parameter [00-27] to 1. When switching to ND (normal duty mode), the frequency will change to 2kHz.
- (3) The default setting of carrier frequency in HD mode is shown into the table on the right, if the setting value is higher than default setting, derating may be required.
- (4) The default setting of carrier frequency in ND mode is 2kHz, if the setting value is higher than default setting, de-rating may be required.
- (5) If control mode is set to SLV mode and maximum frequency is larger than 80Hz, the carrier frequency range is 2-8kHz.
- (6) Option (External Braking Module)

DRIVE MODELS & CODES

THREE PHASE – 230V CLASS

- Without EMI filter
- BU built-in up to 18.5 kW
- IP20 / NEMA 1

Code	Model	Pn@ 230 Vac		Configuration
		HD	ND	
S6N100	VDI100-1007-KBX-2T	0.75 kW	1.5 kW	Internal Braking Unit - Without EMI filter
S6N101	VDI100-1015-KBX-2T	1.5 kW	2.2 kW	Internal Braking Unit - Without EMI filter
S6N102	VDI100-2022-KBX-2T	2.2 kW	3.7 kW	Internal Braking Unit - Without EMI filter
S6N103	VDI100-2037-KBX-2T	3.7 kW	5.5 kW	Internal Braking Unit - Without EMI filter
S6N104	VDI100-2055-KBX-2T	5.5 kW	7.5 kW	Internal Braking Unit - Without EMI filter
S6N105	VDI100-3075-KBX-2T	7.5 kW	11 kW	Internal Braking Unit - Without EMI filter
S6N106	VDI100-4110-KBX-2T	11 kW	15 kW	Internal Braking Unit - Without EMI filter
S6N107	VDI100-4150-KBX-2T	15 kW	18.5 kW	Internal Braking Unit - Without EMI filter
S6N108	VDI100-4185-KBX-2T	18.5 kW	22 kW	Internal Braking Unit - Without EMI filter
S6N109	VDI100-5220-KXX-2T	22 kW	30 kW	Without EMI filter

THREE PHASE – 400V CLASS

- With built-in EMI filter
- BU built-in up to 30 kW
- IP20 / NEMA 1

Code	Model	Pn@ 400 Vac		Configuration
		HD	ND	
S6N110	VDI100-1007-KBX-4-F	0.75 kW	1.5 kW	Internal Braking Unit - With EMI filter
S6N111	VDI100-1015-KBX-4-F	1.5 kW	2.2 kW	Internal Braking Unit - With EMI filter
S6N112	VDI100-1022-KBX-4-F	2.2 kW	3.7 kW	Internal Braking Unit - With EMI filter
S6N113	VDI100-2037-KBX-4-F	3.7 kW	5.5 kW	Internal Braking Unit - With EMI filter
S6N114	VDI100-2055-KBX-4-F	5.5 kW	7.5 kW	Internal Braking Unit - With EMI filter
S6N115	VDI100-3075-KBX-4-F	7.5 kW	11 kW	Internal Braking Unit - With EMI filter
S6N116	VDI100-3110-KBX-4-F	11 kW	15 kW	Internal Braking Unit - With EMI filter
S6N117	VDI100-4150-KBX-4-F	15 kW	18.5 kW	Internal Braking Unit - With EMI filter
S6N118	VDI100-4185-KBX-4-F	18.5 kW	22 kW	Internal Braking Unit - With EMI filter
S6N119	VDI100-4220-KBX-4-F	22 kW	30 kW	Internal Braking Unit - With EMI filter
S6N120	VDI100-5300-KBX-4-F	30 kW	37 kW	Internal Braking Unit - With EMI filter
S6N121	VDI100-5370-KXX-4-F	37 kW	45 kW	With EMI filter
S6N122	VDI100-5450-KXX-4-F	45 kW	55 kW	With EMI filter

- Without EMI filter
- BU built-in up to 30 kW
- IP20 / NEMA 1

Code	Model	Pn@ 400 Vac		Configuration
		HD	ND	
S6N123	VDI100-1007-KBX-4	0.75 kW	1.5 kW	Internal Braking Unit - Without EMI filter
S6N124	VDI100-1015-KBX-4	1.5 kW	2.2 kW	Internal Braking Unit - Without EMI filter
S6N125	VDI100-1022-KBX-4	2.2 kW	3.7 kW	Internal Braking Unit - Without EMI filter
S6N126	VDI100-2037-KBX-4	3.7 kW	5.5 kW	Internal Braking Unit - Without EMI filter
S6N127	VDI100-2055-KBX-4	5.5 kW	7.5 kW	Internal Braking Unit - Without EMI filter
S6N128	VDI100-3075-KBX-4	7.5 kW	11 kW	Internal Braking Unit - Without EMI filter
S6N129	VDI100-3110-KBX-4	11 kW	15 kW	Internal Braking Unit - Without EMI filter
S6N130	VDI100-3150-KBX-4	15 kW	18.5 kW	Internal Braking Unit - Without EMI filter
S6N131	VDI100-4185-KBX-4	18.5 kW	22 kW	Internal Braking Unit - Without EMI filter
S6N132	VDI100-4220-KBX-4	22 kW	30 kW	Internal Braking Unit - Without EMI filter
S6N133	VDI100-5300-KBX-4	30 kW	37 kW	Internal Braking Unit - Without EMI filter
S6N134	VDI100-5370-KXX-4	37 kW	45 kW	Without EMI filter
S6N135	VDI100-5450-KXX-4	45 kW	55 kW	Without EMI filter
S6N136	VDI100-5550-KXX-4	55 kW	75 kW	Without EMI filter

- Without EMI filter
- External BU
- IP00 (*)

Code	Model	Pn@ 400 Vac		Configuration
		HD	ND	
S6N137	VDI100-6750-KXX-4	75 kW	90 kW	Without EMI filter - IP00
S6N138	VDI100-6900-KXX-4	90 kW	110 kW	Without EMI filter - IP00
S6N139	VDI100-71100-KXX-4	110 kW	132 kW	Without EMI filter - IP00
S6N140	VDI100-71320-KXX-4	132 kW	160 kW	Without EMI filter - IP00
S6N141	VDI100-71600-KXX-4	160 kW	185 kW	Without EMI filter - IP00

(*) Available optional NEMA 1 kit.

ACCESSORIES AND OPTIONS

INPUT CHOKE

Code	Model	Dimensions: WxHxd (mm)	Weight (kg)	For VDI100-....
Input choke - Overload HD (150%) - Class 230V 3ph				
S7FF7	LR3-005	150 x 155 x 85	6	1007
S7FF6	LR3-011	180 x 182 x 130	8	1015
S7AB6	LR3y-2075	150 x 155 x 79	4.9	2022
S7AB8	LR3y-3150	150 x 169 x 85	5.5	2037
S7FF4	LR3-022	180 x 182 x 130	7.8	2055
S7FF3	LR3-030	180 x 160 x 185	8.2	3075
S7FF2	LR3-037	180 x 160 x 185	9.5	4110
S7FF1	LR3-055	180 x 180 x 185	12	4150
S7FF1	LR3-055	180 x 180 x 185	12	4185
S7D19	LR3-090	300 x 205 x 265	30	5220
Input choke - Overload HD (150%) - Class 400V 3ph				
S7AAE	LR3y-1015	120 x 125 x 65	1.8	1007
S7AAF	LR3y-1022	120 x 125 x 65	1.9	1015
S7AB3	LR3y-1030	120 x 125 x 65	1.9	1022
S7AAG	LR3y-2040	120 x 125 x 65	2	2037
S7AB6	LR3y-2075	150 x 155 x 79	4.9	2055
S7AB7	LR3y-3110	150 x 155 x 79	5	3075
S7AB8	LR3y-3150	150 x 169 x 85	5.5	3110
S7FF4	LR3-022	180 x 182 x 130	7.8	3150
S7FF4	LR3-022	180 x 182 x 130	7.8	4150
S7FF4	LR3-022	180 x 182 x 130	7.8	4185
S7FF3	LR3-030	180 x 160 x 185	8.2	4220
S7FF2	LR3-037	180 x 160 x 185	9.5	5300
S7FF1	LR3-055	180 x 180 x 185	12	5370
S7FF1	LR3-055	180 x 180 x 185	12	5450
S7D19	LR3-090	300 x 205 x 265	30	5550
(*)				6750 ... 71600

Code	Model	Dimensions: WxHxd (mm)	Weight (kg)	For VDI100-....
Input choke - Overload ND (120%) - Class 230V 3ph				
S7AB6	LR3y-2075	150 x 155 x 79	4.9	1007
S7AB8	LR3y-3150	150 x 169 x 85	5.5	1015
S7FF4	LR3-022	180 x 182 x 130	7.8	2022
S7FF3	LR3-030	180 x 160 x 185	8.2	2037
S7FF2	LR3-037	180 x 160 x 185	9.5	2055
S7FF1	LR3-055	180 x 180 x 185	12	3075
S7FF1	LR3-055	180 x 180 x 185	12	4110
S7D19	LR3-090	300 x 205 x 265	30	4150
S7D19	LR3-090	300 x 205 x 265	30	4185
S7D19	LR3-090	300 x 205 x 265	30	5220
Input choke - Overload ND (120%) - Class 400V 3ph				
S7AB3	LR3y-1030	120 x 125 x 65	1.9	1007
S7AAG	LR3y-2040	120 x 125 x 65	3	1015
S7AB6	LR3y-2075	150 x 155 x 79	4.9	1022
S7AB7	LR3y-3110	150 x 155 x 79	5	2037
S7AB8	LR3y-3150	150 x 169 x 85	5.5	2055
S7FF4	LR3-022	180 x 182 x 130	7.8	3075
S7FF3	LR3-030	180 x 160 x 185	8.2	3110
S7FF3	LR3-030	180 x 160 x 185	8.2	3150
S7FF3	LR3-030	180 x 160 x 185	8.2	4150
S7FF2	LR3-037	180 x 160 x 185	9.5	4185
S7FF1	LR3-055	180 x 180 x 185	12	4220
S7FF1	LR3-055	180 x 180 x 185	12	5300
S7D19	LR3-090	300 x 205 x 265	30	5370
S7D19	LR3-090	300 x 205 x 265	30	5450
S7D19	LR3-090	300 x 205 x 265	30	5550
(*)				6750 ... 71600

(*) 400V class 75kW – 160kW have a built-in DC reactors. If required by the application an AC reactor may be added.

Mains choke listed in this table can only be used for the inverter input side. Do not connect Mains choke to the inverter output side.

OUTPUT CHOKE

Code	Model	Finv_max [Hz]	Fswitch [kHz]	Dimensions WxAHxd (mm)	Weight (kg)	For VDI100-....
Output Choke - Class 230V 1ph						
S7FG1	LU3-001	400	20	120 x 128 x 71	2.7	1007
S7FG2	LU3-003	400	20	180 x 170 x 110	5.2	1015
S7FG3	LU3-005	400	20	180 x 170 x 110	5.2	2022
Output Choke - Class 230V 3ph						
S7FG1	LU3-001	400	20	120 x 128 x 71	2.7	1007
S7FG2	LU3-003	400	20	180 x 170 x 110	5.2	1015
S7FG3	LU3-005	400	20	180 x 170 x 110	5.2	2022
S7FG4	LU3-011	400	20	180 x 180 x 130	8	2037
S7FH2	LU3-015	400	20	180 x 160 x 170	7.5	2055
S7FH3	LU3-022	300	20	180 x 160 x 170	8	3075
S7FH4	LU3-030	300	15	180 x 160 x 180	9.5	4110
S7FH5	LU3-037	300	15	180 x 160 x 180	9.7	4150
S7FH5	LU3-037	300	15	180 x 160 x 180	9.7	4185
S7FH6	LU3-055	300	15	240 x 210 x 180	14	5220

Code	Model	Finv_max [Hz]	Fswitch [kHz]	Dimensions WxAHxd (mm)	Weight (kg)	For VDI100-....
Output Choke - Class 400V 3ph						
S7FG1	LU3-001	400	20	120 x 128 x 71	2.7	1007
S7FG1	LU3-001	400	20	120 x 128 x 71	2.7	1015
S7FG1	LU3-001	400	20	120 x 128 x 71	2.7	1022
S7FG3	LU3-005	400	20	180 x 170 x 110	5.2	2037
S7FG4	LU3-011	400	20	180 x 180 x 130	8	2055
S7FG4	LU3-011	400	20	180 x 180 x 130	8	3075
S7FH2	LU3-015	400	20	180 x 160 x 170	7.5	3110
S7FH3	LU3-022	300	20	180 x 160 x 170	8	3150
S7FH3	LU3-022	300	20	180 x 160 x 170	8	4150-F
S7FH3	LU3-022	300	20	180 x 160 x 170	8	4185
S7FH4	LU3-030	300	15	180 x 160 x 180	9.5	4220
S7FH5	LU3-037	300	15	180 x 160 x 180	9.7	5300
S7FH5	LU3-037	300	15	180 x 160 x 180	9.7	5370
S7FH6	LU3-055	300	15	240 x 210 x 180	14	5450
S7F10	LU3-090	200 (*)	16	240 x 210 x 200	18.5	5550
S7F10	LU3-090	200 (*)	16	240 x 210 x 200	18.5	6750
S7F10	LU3-090	200 (*)	16	240 x 210 x 200	18.5	6900
S7FH8	LU3-160	200 (*)	16	300 x 260 x 240	27.5	71100
S7FH8	LU3-160	200 (*)	16	300 x 260 x 240	27.5	71320
S7FH8	LU3-160	200 (*)	16	300 x 260 x 240	27.5	71600

(*) It's not possible to operate at high frequencies because the voltage drops are very big for high currents and very long cables.

ACCESSORIES AND OPTIONS

BRAKING RESISTORS AND BRAKING UNIT

VDI100-....	Braking unit			Braking resistor			Dimensions - Weight W x H x d (mm) - (kg)	Braking torque (Peak / Continues) 10%ED	Minimum Resistance ⁽¹⁾	
	Model (Code)	Q.ty	Code	Type	Protection degree	Q.ty			(Ω)	(W)
Class 230V 1ph										
1007	-	-	S8T1DB	RF 300 DT 200R	IP44	1	260 x 106 x 47 - (1.4)	119%	17	1000
1015	-	-	S8SA15	RF 200 100R	IP44	1	300 x 27 x 27 - (0.57)	119%	17	1000
2022	-	-	S8SA14	RF 200 68R	IP44	1	300 x 36 x 27 - (0.57)	115%	17	1000
Class 230V 3ph										
1007	-	-	S8T1DB	RF 300 DT 200R	IP44	1	260 x 106 x 47 - (1.4)	119%	17	1000
1015	-	-	S8SA15	RF 200 100R	IP44	1	300 x 27 x 27 - (0.57)	119%	17	1000
2022	-	-	S8SA14	RF 200 68R	IP44	1	300 x 36 x 27 - (0.57)	115%	17	1000
2037	-	-	S6F62	RFH 600 40R	IP44	1	320 x 27 x 36 - (0.6)	119%	17	1000
2055	-	-	S8SA27	RFH 400 30R	IP44	1	320 x 27 x 36 - (0.6)	108%	17	1000
3075	-	-	S8T0CZ	RFPD 750 DT 26R	IP44	1	200 x 106 x 70 - (1.7)	119%	11	1500
4110	-	-	S8SA33	BRT 2K4 13R6	IP20	1	440 x 180 x 220 - (7.5)	117%	11	1500
4150	-	-	S8T00H	BRT4K0-11R6	IP20	1	625 x 100 x 250	119%	7	2400
4185	-	-	S8SA1	RF 5K0 11R6	IP20	1	545 x 200 x 200	119%	7	2400
5220	BU-2-VDI100 (S6N142)	1	S8SA32	BRT 4K8 6R8	IP20	1	570 x 180 x 330 - (11)	117%	5,5	3000
Class 400V 3ph										
1007	-	-	S8SA26	RFH 220 750R	IP44	1	220 x 27 x 36 - (0.33)	126%	120	600
1015	-	-	S8T0CR	RF 300 DT 400R	IP44	1	260 x 106 x 47 - (1.4)	119%	120	600
1022	-	-	S8T0CP	RF 220 T 250R	IP44	1	300 x 36 x 27 - (0.5)	126%	100	680
2037	-	-	S6F64	RFH 600 160R	IP44	1	320 x 27 x 36 - (0.6)	126%	60	1200
2055	-	-	S8SA31	RFMTX 400 130R	IP44	1	580 x 140 x 110 - (4.2)	102%	43	1600
3075	-	-	S8T0CZ	RFPD 750 DT 26R	IP44	1	200 x 106 x 70 - (1.7)	99%	43	1600
3110	-	-	S8SA30	BRT 1K6 52R	IP20	1	580 x 140 x 110 - (4.2)	126%	43	1600
3150	-	-	-	-	-	-	-	-	-	-
4150	-	-	S8SA29	BRT 1K5 40R	IP20	1	440 x 140 x 110 - (3)	119%	22	3000
4185	-	-	S8SA36	BRT 4K8 32R	IP20	1	570 x 180 x 330 - (11)	119%	14	4800
4220	-	-	S8SA35	BRT 4K8 27R2	IP20	1	570 x 180 x 330 - (11)	117%	14	4800
5300	-	-	S8SA34	BRT 6K 20R	IP20	1	570 x 180 x 330 - (11)	119%	11	6000
5370	BU-4-VDI100 (S6N143)	2	S8SA36	BRT 4K8 32R	IP20	2	570 x 180 x 330 - (11)	119%	19,2	3600
5450	BU-4-VDI100 (S6N143)	2	S8SA35	BRT 4K8 27R2	IP20	2	570 x 180 x 330 - (11)	117%	19,2	3600
5550	BU-4-VDI100 (S6N143)	2	S8SA34	BRT 6K 20R	IP20	2	570 x 180 x 330 - (11)	126%	19,2	3600
6750	BU-4-VDI100 (S6N143)	3	S8SA34	BRT 6K 20R	IP20	3	570 x 180 x 330 - (11)	139%	19,2	3600
6900	BU-4-VDI100 (S6N143)	3	S8SA34	BRT 6K 20R	IP20	3	570 x 180 x 330 - (11)	115%	19,2	3600
71100	BU-4-VDI100 (S6N143)	4	S8SA34	BRT 6K 20R	IP20	4	570 x 180 x 330 - (11)	125%	19,2	3600
71320	BU-4-VDI100 (S6N143)	4	S8SA34	BRT 6K 20R	IP20	4	570 x 180 x 330 - (11)	111%	19,2	3600
71600	BU-4-VDI100 (S6N143)	5	S8SA34	BRT 6K 20R	IP20	5	570 x 180 x 330 - (11)	112%	19,2	3600

Inverters ratings 230V Class 0,75 - 18.5kW / 400V Class 0,75 - 30kW have a built-in braking transistor. For applications requiring a greater braking torque an external braking resistor can be connected to terminals B1 / P and B2; for inverter ratings above 230V Class 18.5 kW / 400V Class 30 kW an external braking unit (connected to (+) / (-) of the inverter) and a braking resistor (connected to two ends of the detection module BR+ / BR-) is required.

(1): Minimum resistance is the acceptable minimum value of the braking resistor for a single braking unit.

VDI100 GENERAL PURPOSE FULL VECTOR INVERTER

EMI FILTERS

Code	Model	Dimensions: WxHxd (mm)	Weight (kg)	For VDI100-....
Overload HD (150%) - Class 400V 3ph				
S7GHL	EMI-FTF-480-7	190 x 40 x 70	0.6	1007
S7GHL	EMI-FTF-480-7	190 x 40 x 70	0.6	1015
S7GHL	EMI-FTF-480-7	190 x 40 x 70	0.6	1022
S7GHO	EMI-FTF-480-16	250 x 45 x 70	0.8	2037
S7GHO	EMI-FTF-480-16	250 x 45 x 70	0.8	2055
S7GHO	EMI-FTF-480-16	250 x 45 x 70	0.8	3075
S7GHP	EMI-FTF-480-30	270 x 50 x 85	1	3110
S7GHP	EMI-FTF-480-30	270 x 50 x 85	1	3150
S7GHP	EMI-FTF-480-30	270 x 50 x 85	1	4150
S7GOA	EMI-FTF-480-42	310 x 50 x 85	1.3	4185
S7GOB	EMI-FTF-480-55	250 x 85 x 90	1.9	4220
S7GOC	EMI-FTF-480-75	270 x 80 x 135	2.6	5300
S7GOC	EMI-FTF-480-75	270 x 80 x 135	2.6	5370
S7GOD	EMI-FTF-480-100	270 x 90 x 150	3	5450
S7GOE	EMI-FTF-480-130	270 x 90 x 150	3.6	5550
S7GOF	EMI-FTF-480-180	400 x 120 x 170	6.2	6750
S7GOF	EMI-FTF-480-180	400 x 120 x 170	6.2	6900
S7DGG	EMI 480-250	300 x 260 x 135	13	71100
S7DGG	EMI 480-250	300 x 260 x 135	13	71320
S7DGI	EMI 480-400	300 x 260 x 135	13.4	71600

Code	Model	Dimensions: WxHxd (mm)	Weight (kg)	For VDI100-....
Overload ND (120%) - Class 400V 3ph				
S7GHL	EMI-FTF-480-7	190 x 40 x 70	0.6	1007
S7GHL	EMI-FTF-480-7	190 x 40 x 70	0.6	1015
S7GHL	EMI-FTF-480-7	190 x 40 x 70	0.6	1022
S7GHO	EMI-FTF-480-16	250 x 45 x 70	0.8	2037
S7GHO	EMI-FTF-480-16	250 x 45 x 70	0.8	2055
S7GHO	EMI-FTF-480-16	250 x 45 x 70	0.8	3075
S7GHP	EMI-FTF-480-30	270 x 50 x 85	1	3110
S7GHP	EMI-FTF-480-30	270 x 50 x 85	1	3150
S7GHP	EMI-FTF-480-30	270 x 50 x 85	1	4150
S7GOA	EMI-FTF-480-42	310 x 50 x 85	1.3	4185
S7GOB	EMI-FTF-480-55	250 x 85 x 90	1.9	4220
S7GOC	EMI-FTF-480-75	270 x 80 x 135	2.6	5300
S7GOC	EMI-FTF-480-75	270 x 80 x 135	2.6	5370
S7GOC	EMI-FTF-480-75	270 x 80 x 135	2.6	4220
S7GOD	EMI-FTF-480-100	270 x 90 x 150	3	5300
S7GOE	EMI-FTF-480-130	270 x 90 x 150	3.6	5370
S7GOF	EMI-FTF-480-180	400 x 120 x 170	6.2	5450
S7GOF	EMI-FTF-480-180	400 x 120 x 170	6.2	5550
S7DGG	EMI 480-250	300 x 260 x 135	13	6750
S7DGG	EMI 480-250	300 x 260 x 135	13	6900
S7DGI	EMI 480-400	300 x 260 x 135	13.4	71100
S7DGI	EMI 480-400	300 x 260 x 135	13.4	71320
S7DGL	EMI 480-600	300 x 260 x 135	13.6	71600

Install an EMC filter on power supply side to eliminate noise transmitted between the power line and the inverter. The inverter EMI filter above meets the EN 61800:2004/A1:2012 specification. 400V Class inverter can be ordered with EMC filter (-F models). VDI100-...-2T (230V Class) models are not provided with internal / external filters.

A. VDI100-...-4-F series with EMC filter (-F models)

VDI100-...-4-F series inverters are equipped with an EMC filter able to guarantee the performance levels required by EN 61800:2004/A1:2012 standard:

- sizes 1007 to 3110: category C2 with a maximum of 10 meters of shielded motor cable,
- sizes 4150 to 5450: category C3 with a maximum of 10 meters of shielded motor cable.

B. External Input EMI Filter

VDI100-...-4 series inverters equipped with external filter above, are able to guarantee the performance levels required by EN 61800:2004/A1:2012 standard, with the same behaviour of above filter.

ACCESSORIES AND OPTIONS

BRAKING UNIT

Code	Model	Description
S6N142	BU-2-VDI100	For VDI100 230V Class
S6N143	BU-4-VDI100	For VDI100 400V Class

NEMA 1 KIT (FOR SIZES 6 AND 7)

Code	Model	Description
S6N147	NM1-S6-VDI100	VDI100 frame 6 NEMA 1 kit
S6N148	NM1-S7-VDI100	VDI100 frame 7 NEMA 1 kit

OTHER OPTIONS

Code	Model	Description
Communication modules		
S6N218	EXP-PDP-BDI/VDI	Profibus DP interface module
S6N219	EXP-TCPIP-BDI/VDI	Ethernet TCP/IP interface module
S6N220	EXP-DN-BDI/VDI	DeviceNet interface module
S6N221	EXP-CAN-BDI/VDI	CanBus interface module
Encoder cards		
S6N222	EXP-LD-VDI100	Digital incremental Line driver encoder card
S6N223	EXP-OC-VDI100	Digital incremental open collector encoder card
S6N224	EXP-LD-PM-VDI100	Digital incremental line driver encoder card for Permanent Magnet motor
S6N225	EXP-RS-PM-VDI100	Resolver card for Permanent Magnet motor and Asynchronous
S6N226	EXP-SC-PM-VDI100	SinCos encoder card for Permanent Magnet motor
Others		
S6N228	Memory KB-BDI/VDI	Copy unit
S6N229	Cable RJ45 to USB 1.8m	RJ45 to USB connecting cable (1.8 m. cable)
S6N230	Cable RJ45 to USB 3m	RJ45 to USB connecting cable (3 m. cable)
S6N231	KB-LCD-VDI100	LCD keypad
S6N233	KB-BLI-VDI100	Blind cover
S6N234	KB cable 1m	Keypad extension cable 1 m
S6N235	KB cable 2m	Keypad extension cable 2 m
S6N236	KB cable 3m	Keypad extension cable 3 m
S6N237	KB cable 5m	Keypad extension cable 5 m
S6N242	Protective cover VDI100 Size 1	Protective cover for VDI100 Size 1
S6N243	Protective cover VDI100 Size 2	Protective cover for VDI100 Size 2
S6N244	Protective cover VDI100 Size 4	Protective cover for VDI100 Size 4

SOFTWARE

GF-eXpress PROGRAMMING SOFTWARE

Applications

- > Configuring parameters of Gefran devices (Instruments, Drives, Sensors)
- > Tuning control parameters with on-line tests and trends
- > Managing parameter archive for multiple configuration.

Features

- > Guided product selection
- > Multiple languages
- > Creation and storage of recipes
- > Oscilloscope
- > Simplified settings
- > Parameter printout
- > Network autoscan



GF_eXpress software configures the parameters of the automation components, drives and sensors in the Gefran catalogue.

The graphic interface makes selecting and configuring parameters easy and intuitive. Devices are grouped according to product type and functions.

Products are searched by means of a context search and a display of product photos.

This provides a single device library for all Gefran products.

Complete configuration information for every device is given in XML format to facilitate expansion of the catalogue and parameters.



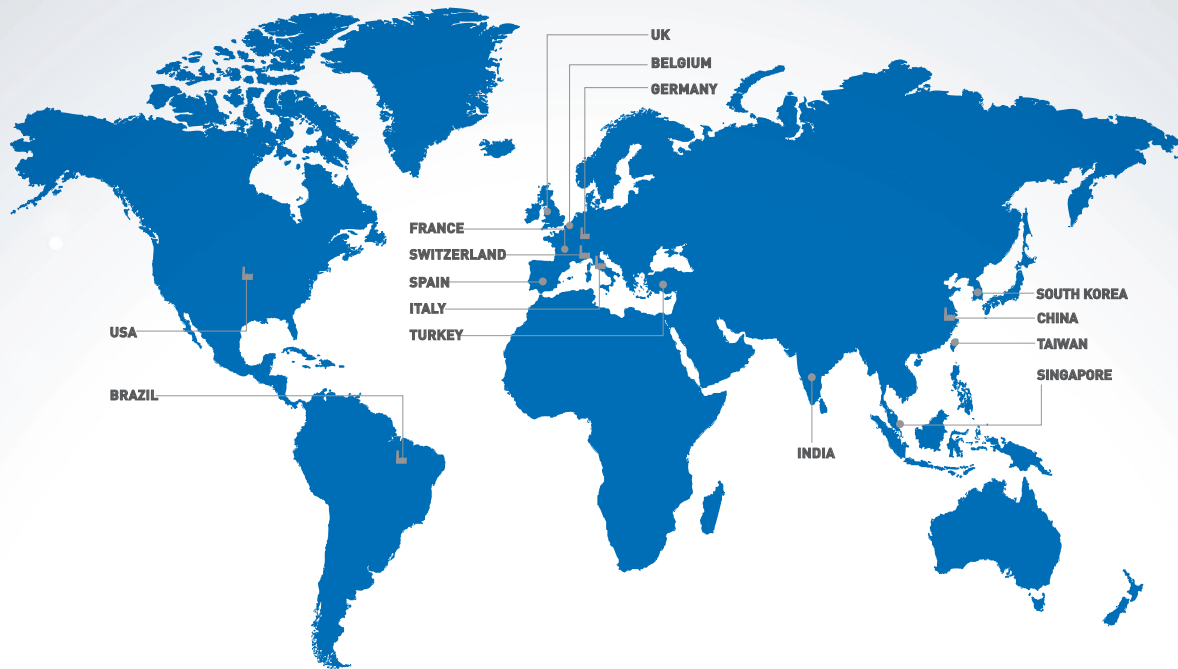

GEFRAN DEUTSCHLAND GmbH

Philipp-Reis-Straße 9a
D-63500
Seligenstadt
Ph. +49 (0) 61828090
Fax +49 (0) 6182809222
vertrieb@gefran.de

SIEI AREG - GERMANY

Gottlieb-Daimler Strasse 17/3
D-74385
Pleidelshheim
Ph. +49 (0) 7144 897360
Fax +49 (0) 7144 8973697
info@sieiareg.de

SENSORMATE AG

Steigweg 8,
CH-8355 Aadorf, Switzerland
Ph. +41(0)52-2421818
Fax +41(0)52-3661884
http://www.sensormate.ch

GEFRAN FRANCE SA

4, rue Jean Desparmet
BP 8237
69355 LYON Cedex 08
Ph. +33 (0) 478770300
Fax +33 (0) 478770320
commercial@gefran.fr

GEFRAN BENELUX NV

ENA 23 Zone 3, nr. 3910
Lammerdries-Zuid 14A
B-2250 OLEN
Ph. +32 (0) 14248181
Fax +32 (0) 14248180
info@gefran.be

GEFRAN UK Ltd

Unit 7 Brook Business Centre
54a Cowley Mill Road
Uxbridge
UB8 2FX
Ph. +44 (0) 8452 604555
Fax +44 (0) 8452 604556
sales@gefran.co.uk

GEFRAN ESPAÑA

Calle Vic, números 109-111
08160 - MONTMELÓ
(BARCELONA)
Ph. +34 934982643
Fax +34 935721571
comercial.espana@gefran.es

GEFRAN MIDDLE EAST ELEKTRIK VE ELEKTRONIK San. ve Tic. Ltd. Sti

Yesilkoy Mah. Ataturk
Cad. No: 12/1 B1 Blok K:12
D: 389 Bakirkoy /Istanbul TURKIYE
Ph. +90212 465 91 21
Fax +90212 465 91 22

GEFRAN SIEI Drives Technology Co., Ltd

No. 1285, Beihe Road, Jiading
District, Shanghai, China 201807
Ph. +86 21 69169898
Fax +86 21 69169333
info@gefran.com.cn

GEFRAN SIEI - ASIA

31 Ubi Road 1
#02-07,
Aztech Building,
Singapore 408694
Ph. +65 6 8418300
Fax +65 6 7428300
info@gefran.com.sg

GEFRAN INDIA

Survey No. 191/A/1,
Chinchwad Station Road, Chinchwad,
Pune-411033, Maharashtra
Ph. +91 20 6614 6500
Fax +91 20 6614 6501
gefran.india@gefran.in

GEFRAN TAIWAN

No.141, Wenzhi Rd.,
Zhongli City,
Taoyuan County 32054,
Taiwan (R.O.C.)
Ph. +886-3-4273697
eddie.liao@gefran.com.sg

GEFRAN SOUTH KOREA

Room #1207, Hogue-Dong Anyang
IT Valley 16-39, LS-ro 91Beon-gil,
Dongan-gu, Anyang-si, Gyeonggi-do,
431-848, South Korea
Ph. +82 70 7578 8680

GEFRAN Inc.

8 Lowell Avenue
WINCHESTER - MA 01890
Toll Free 1-888-888-4474
Fax +1 (781) 7291468
info.us@gefran.com

GEFRAN BRASIL ELETROELETRÔNICA

Avenida Dr. Altino Arantes,
377 Vila Clementino
04042-032 SÃO PAULO - SP
Ph. +55 (0) 1155851133
Fax +55 (0) 1132974012
comercial@gefran.com.br

GEFRAN HEADQUARTER

Via Sebina, 74
25050 PROVAGLIO D'ISEO (BS) ITALY
Ph. +39 03098881
Fax +39 0309839063

Drive & Motion Control Unit

Via Carducci, 24
21040 GERENZANO (VA) ITALY
Ph. +39 02967601
Fax +39 029682653
info.motion@gefran.com

Technical Assistance:
technohelp@gefran.com

Customer Service
motioncustomer@gefran.com
Ph. +39 02 96760500
Fax +39 02 96760278



FM 608910



www.gefran.com

GEFRAN

You know we are there